

FIG. 1

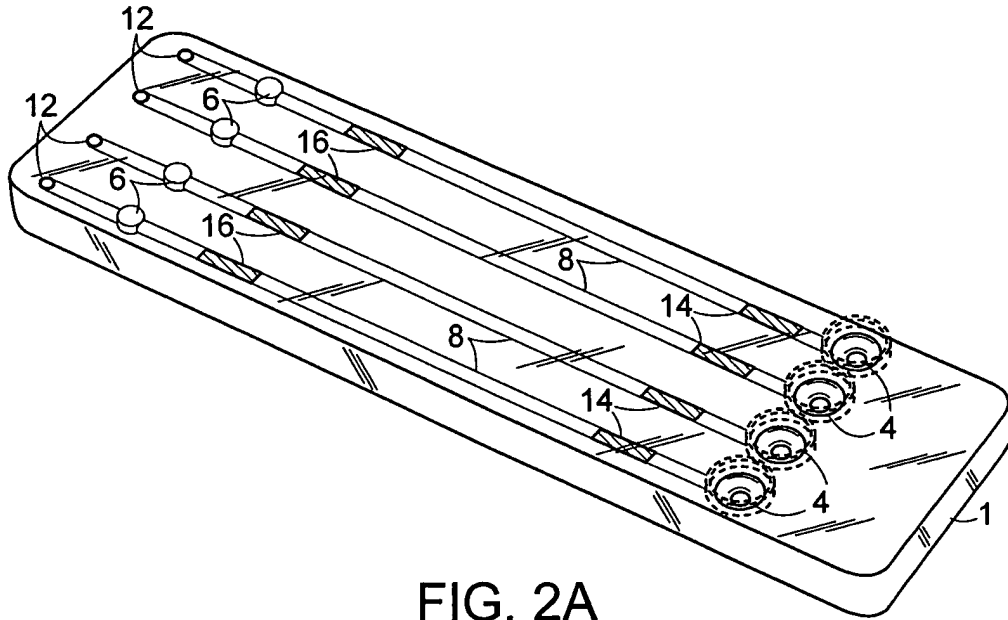

FIG. 2A

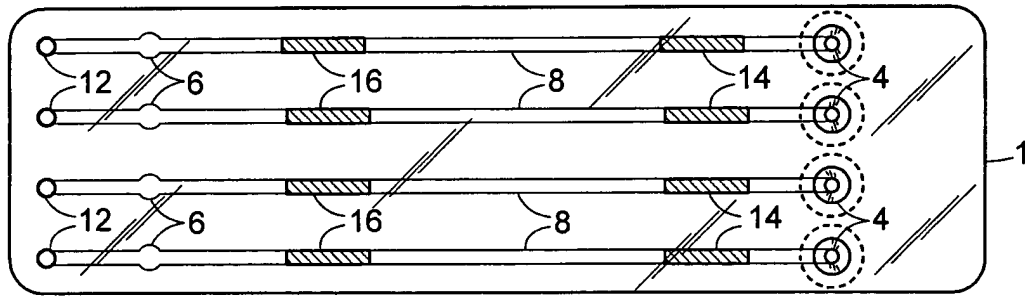

FIG. 2B



FIG. 2C

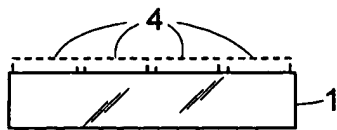

FIG. 2D

3/20

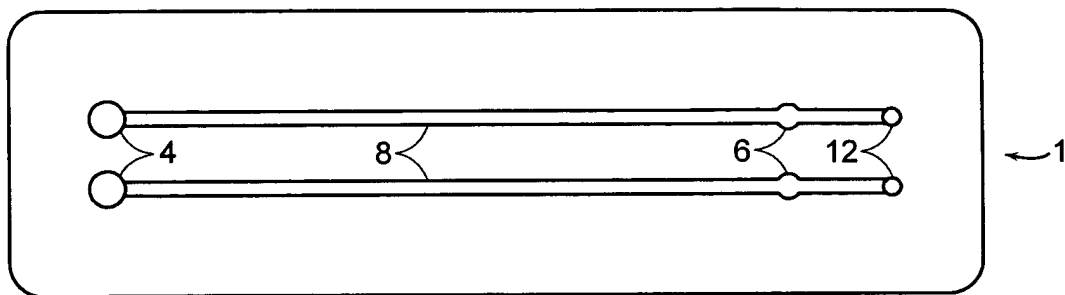

FIG. 3A

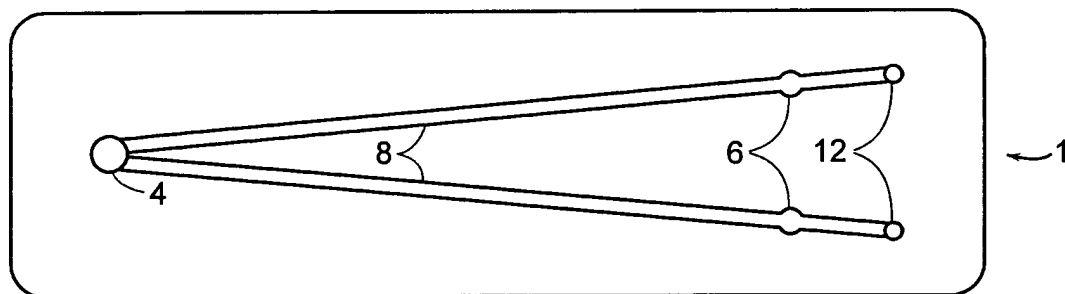

FIG. 3B

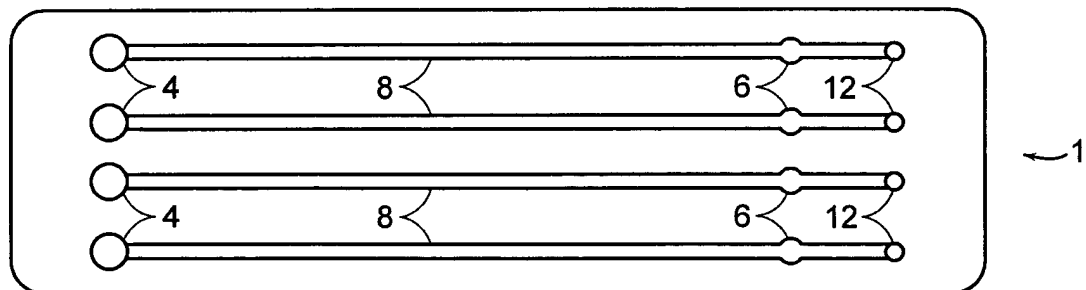

FIG. 4A

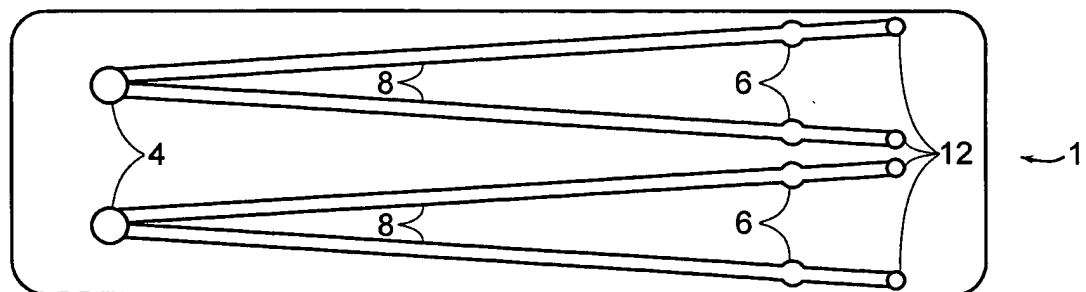

FIG. 4B

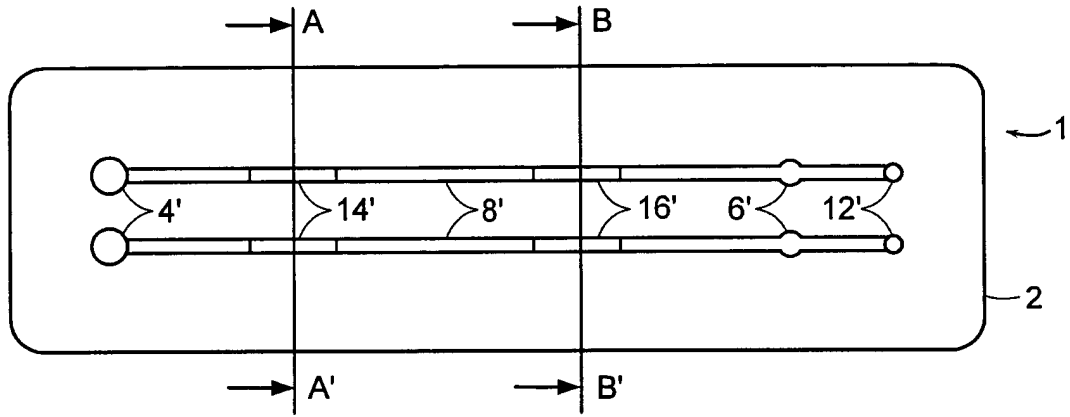

FIG. 5A

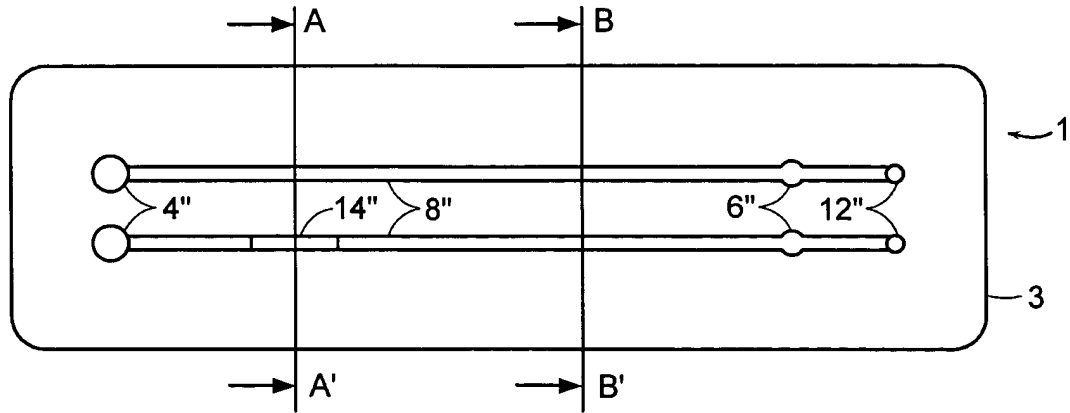

FIG. 5B

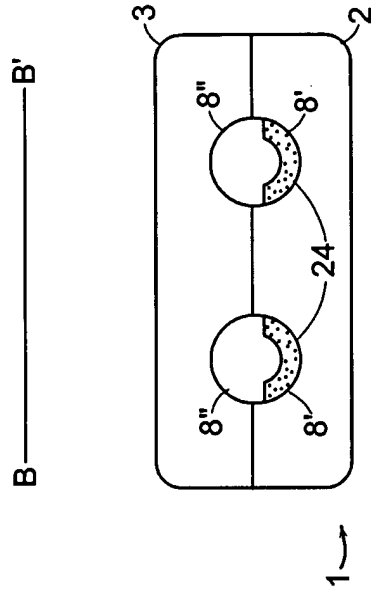

FIG. 5D

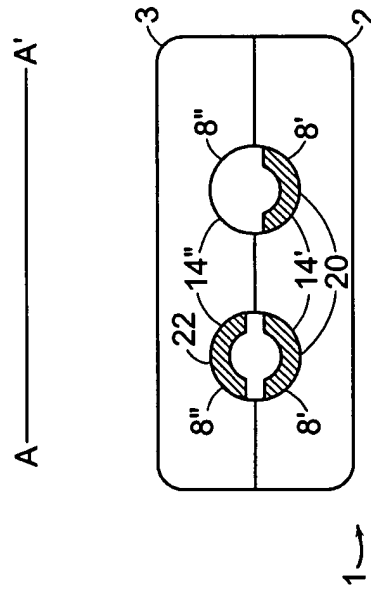

FIG. 5C

6/20

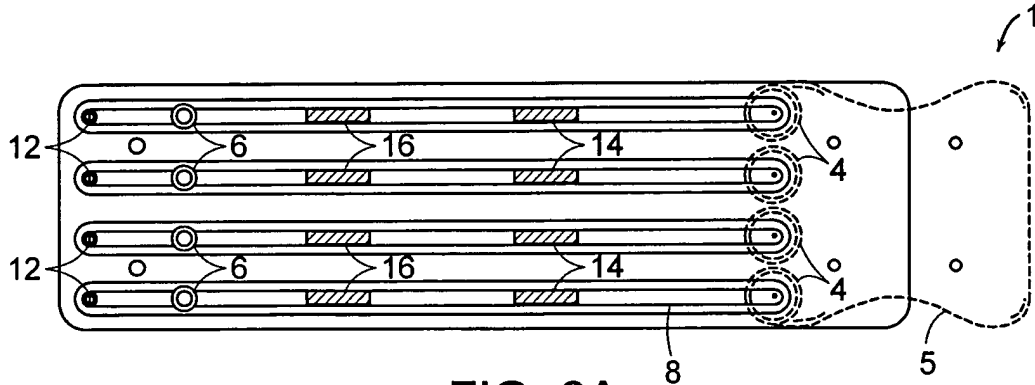

FIG. 6A

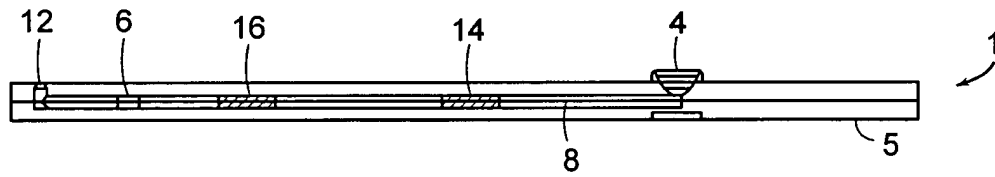

FIG. 6B

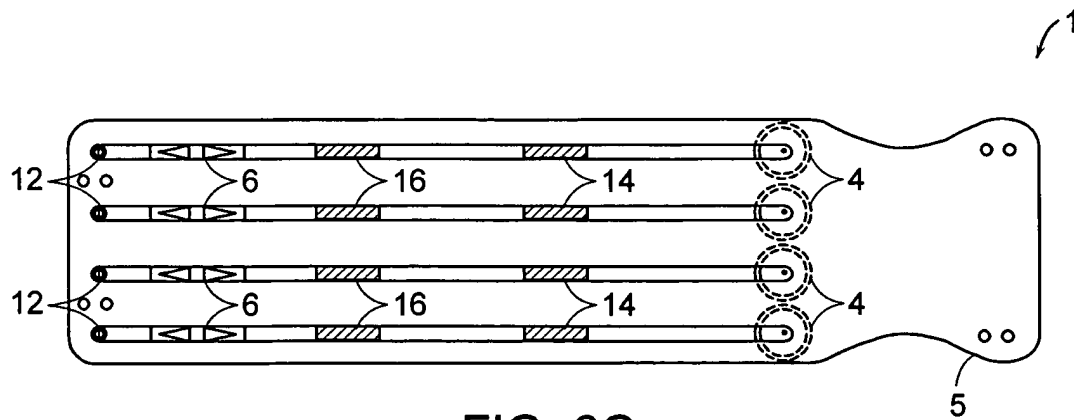

FIG. 6C

7/20

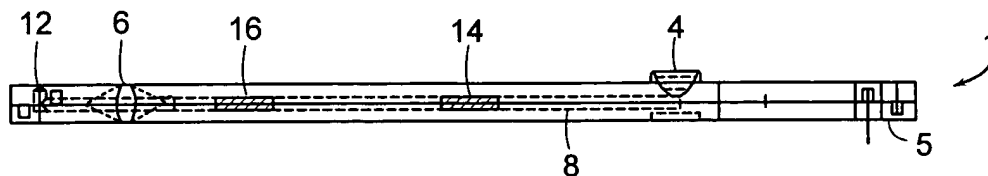

FIG. 6D

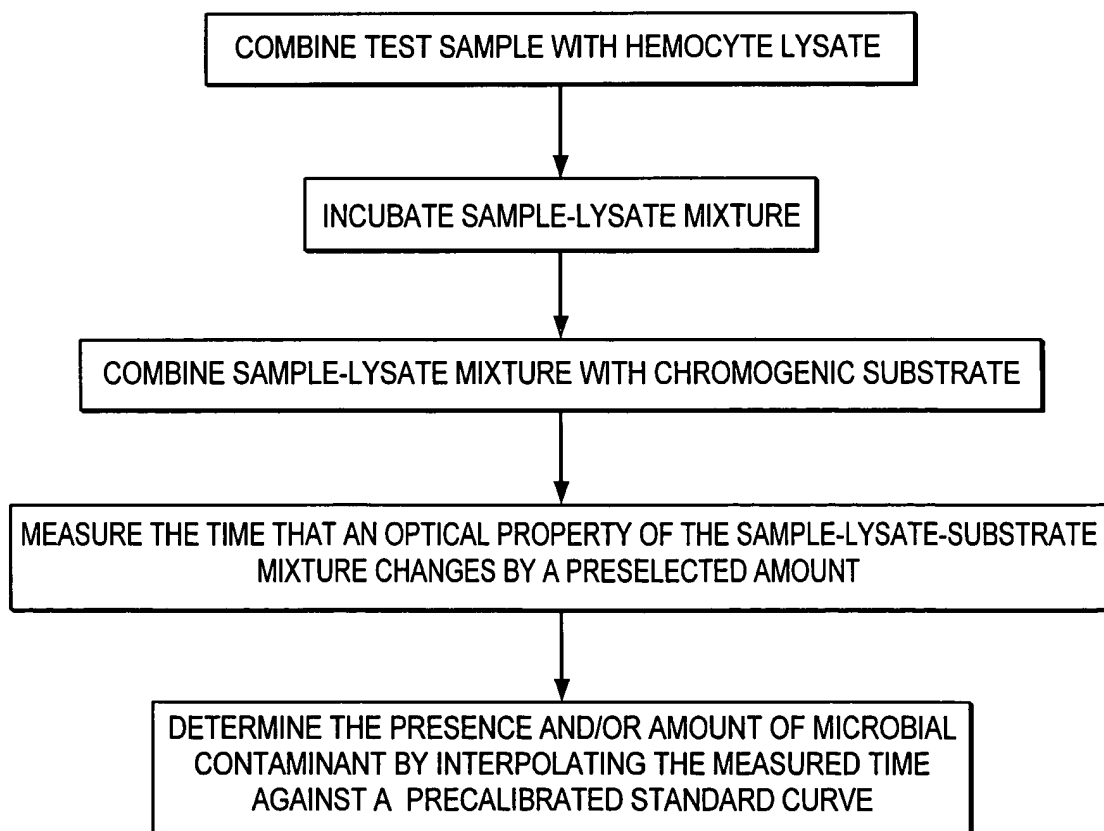

FIG. 7

8/20

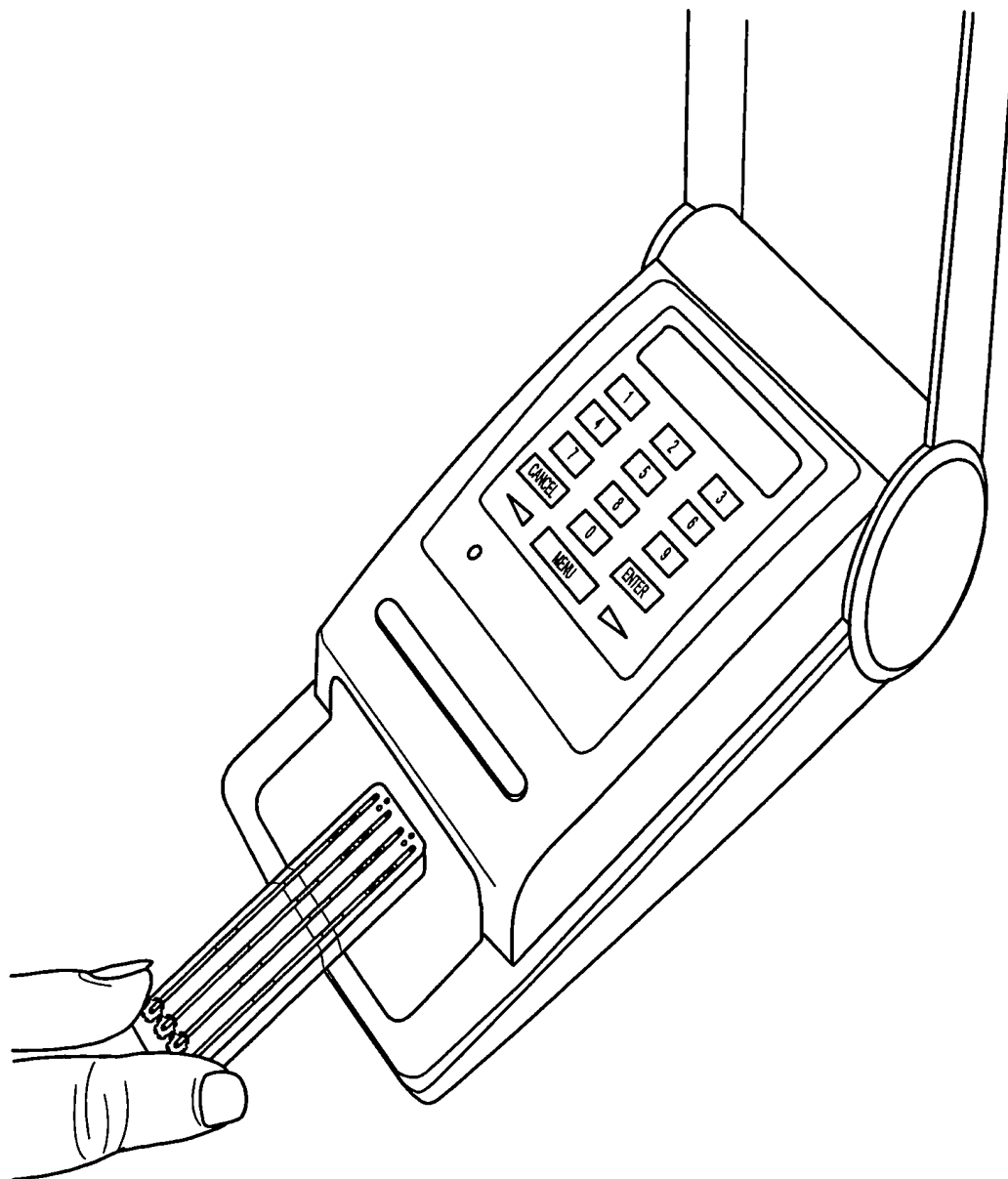

FIG. 8A



9/20

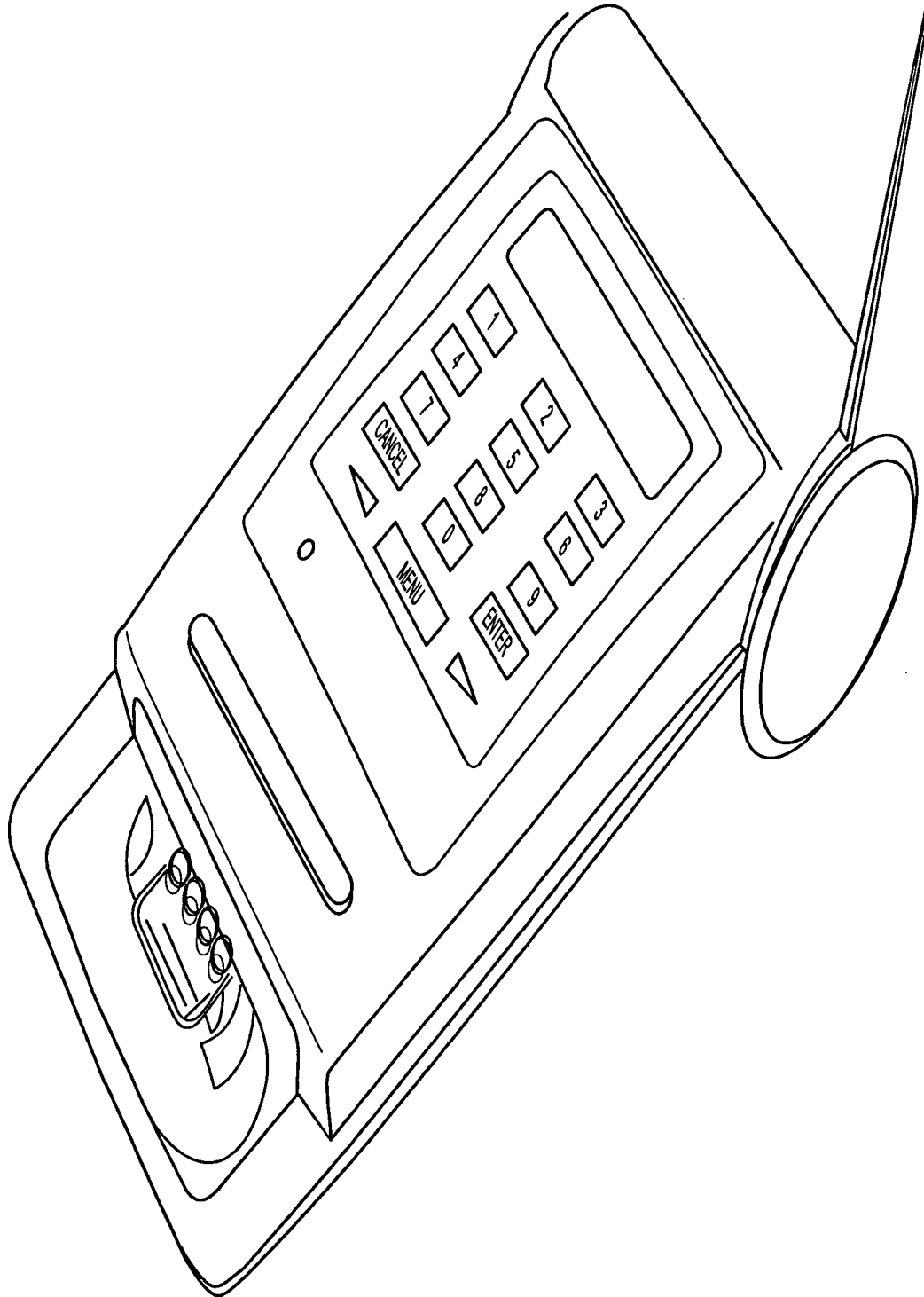

FIG. 8B

10/20

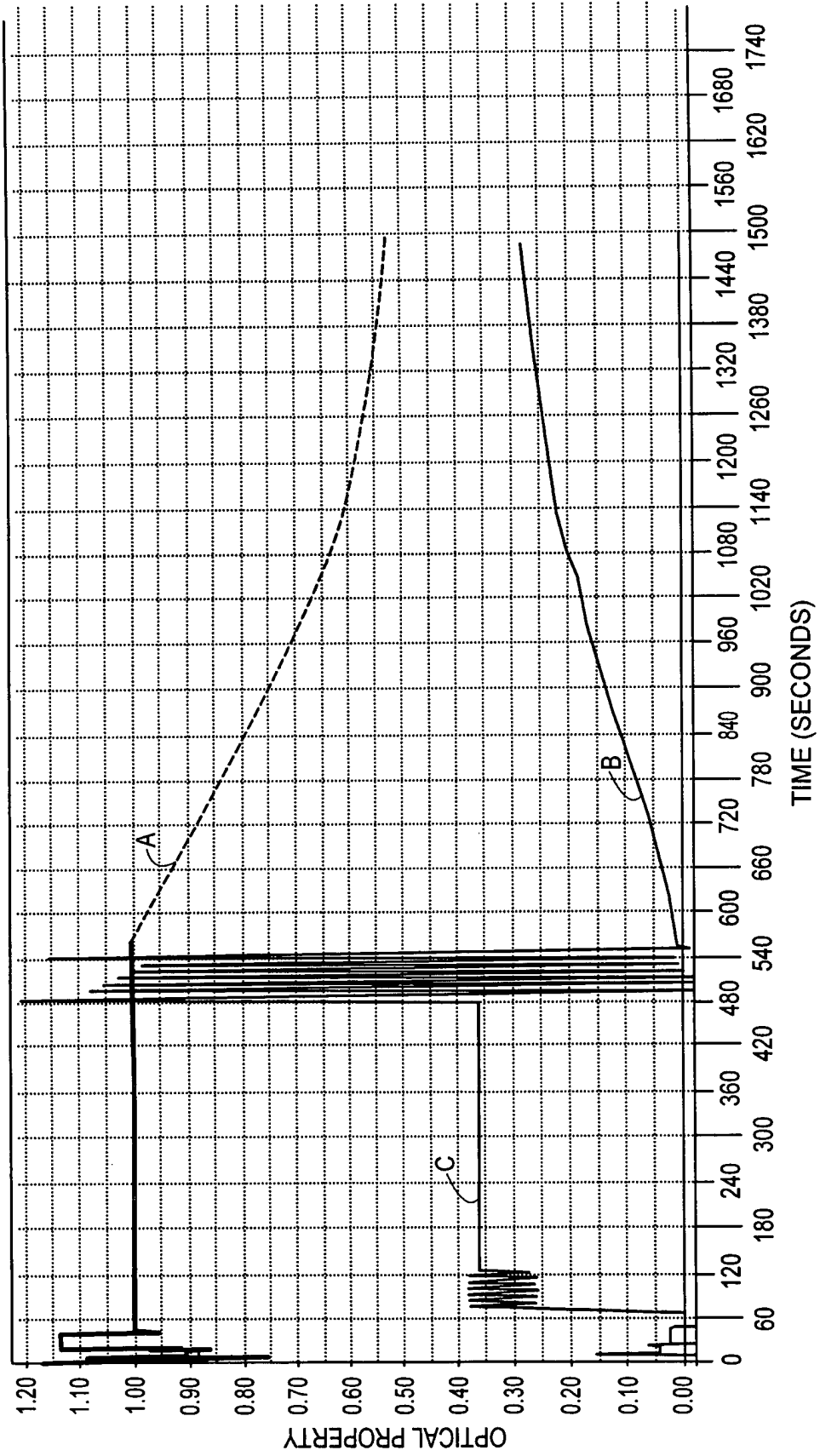

FIG. 9

11/20

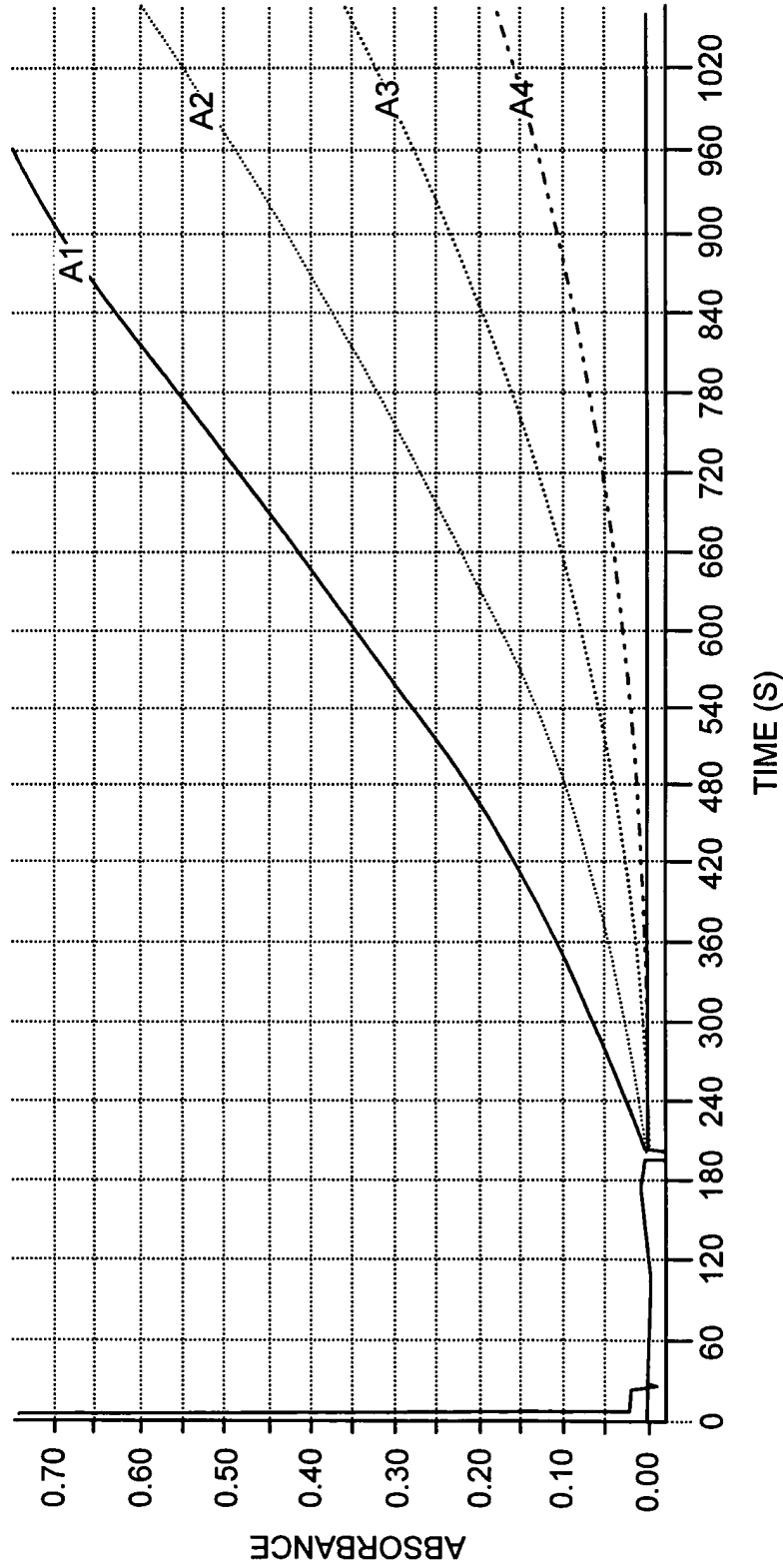

FIG. 10A

12/20

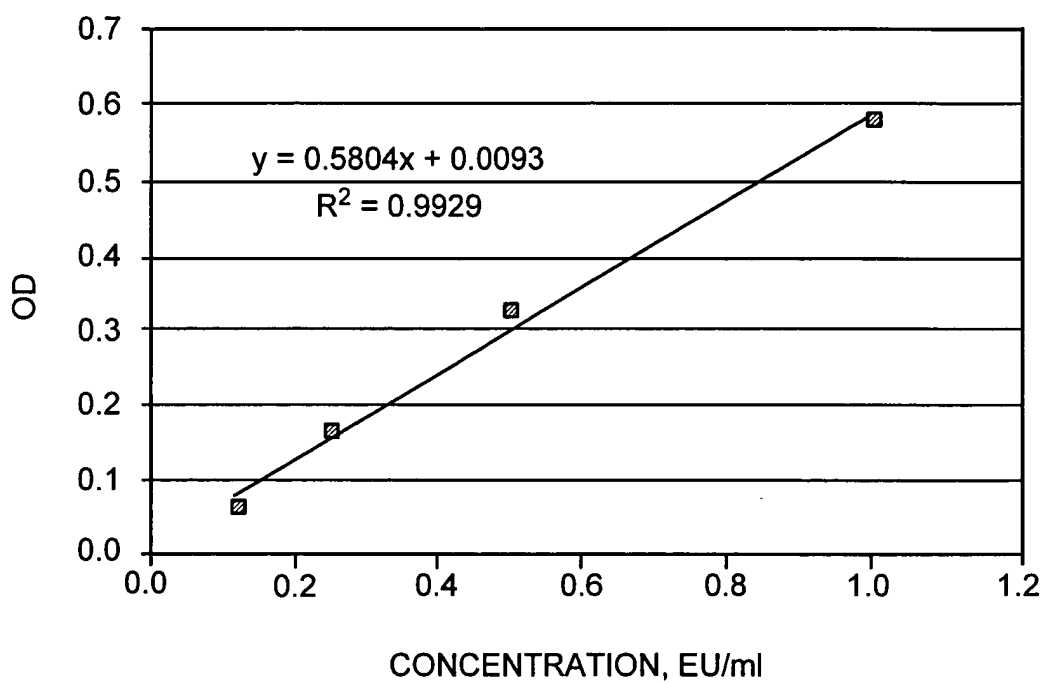

FIG. 10B

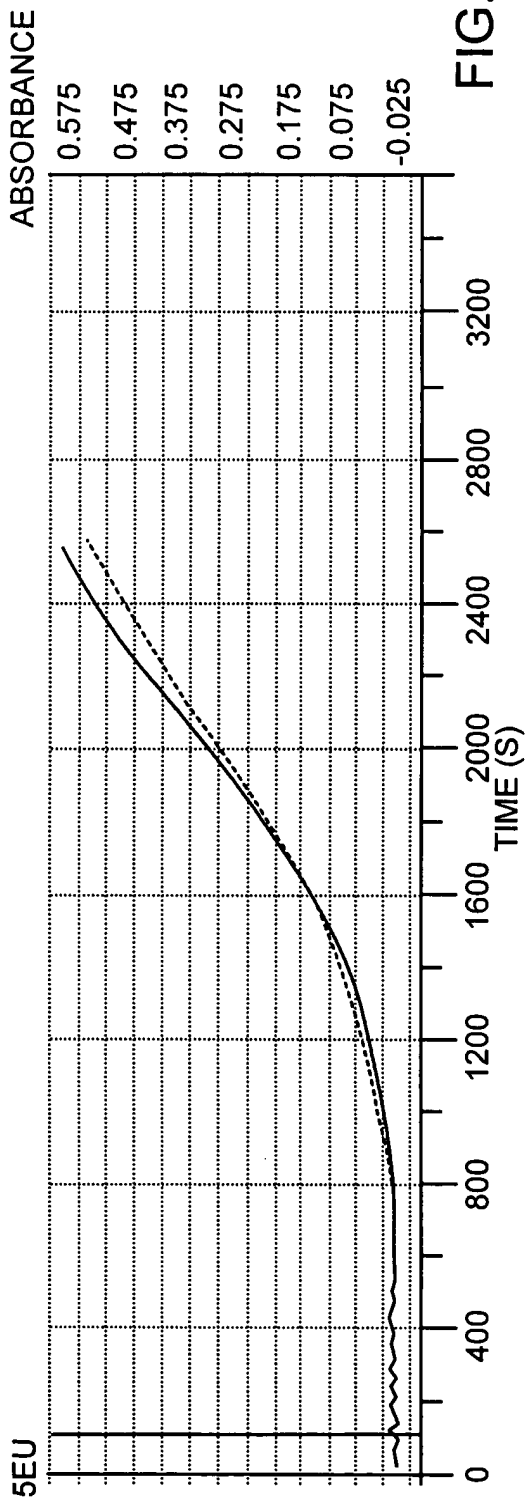

FIG. 11A

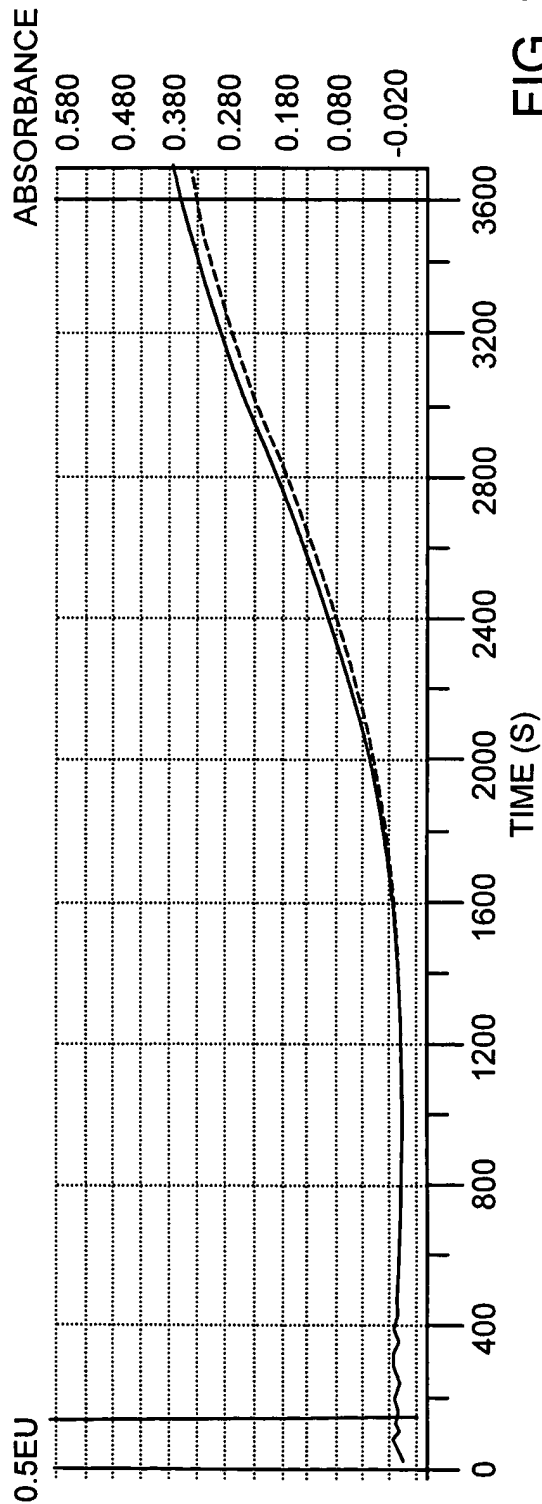

FIG. 11B

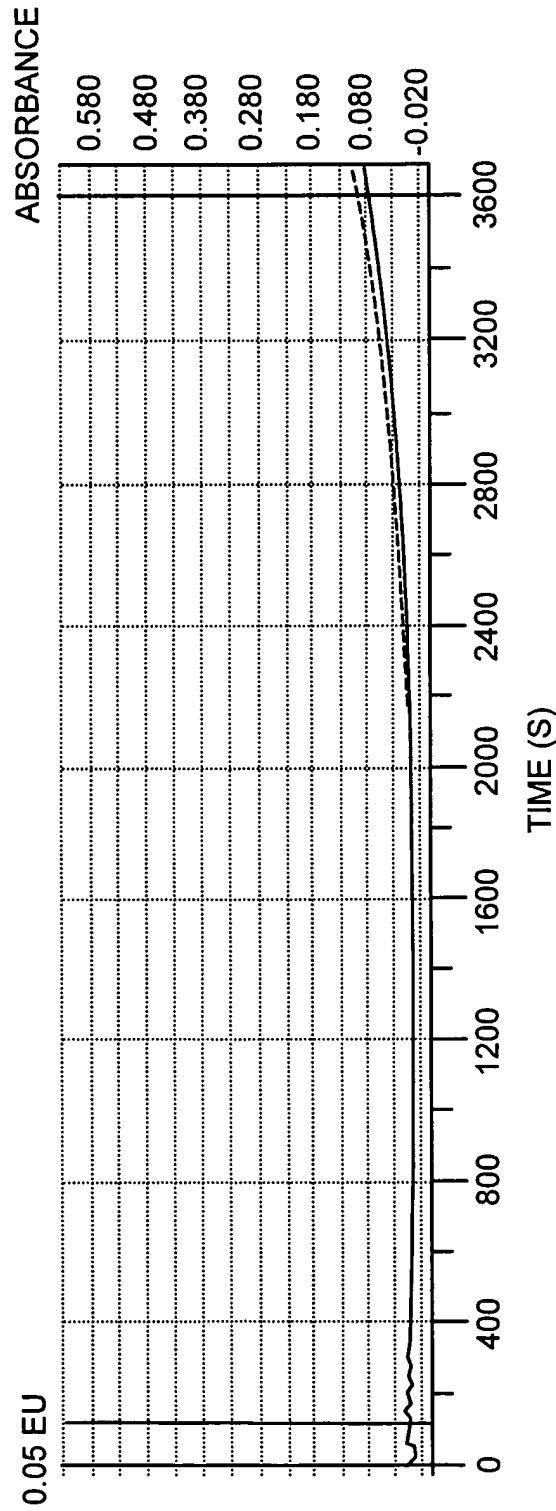

FIG. 11C

15/20

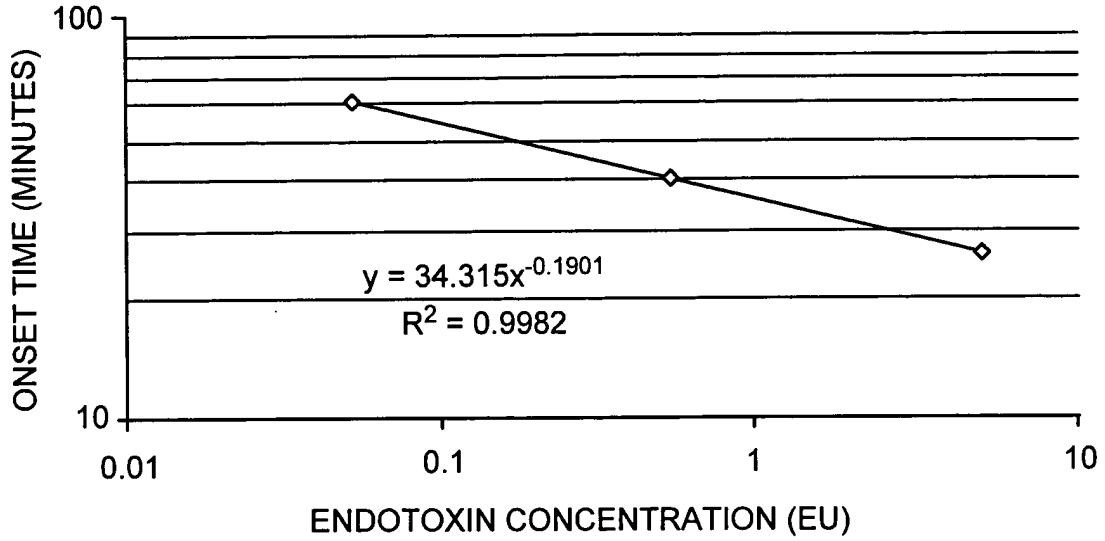

FIG. 11D

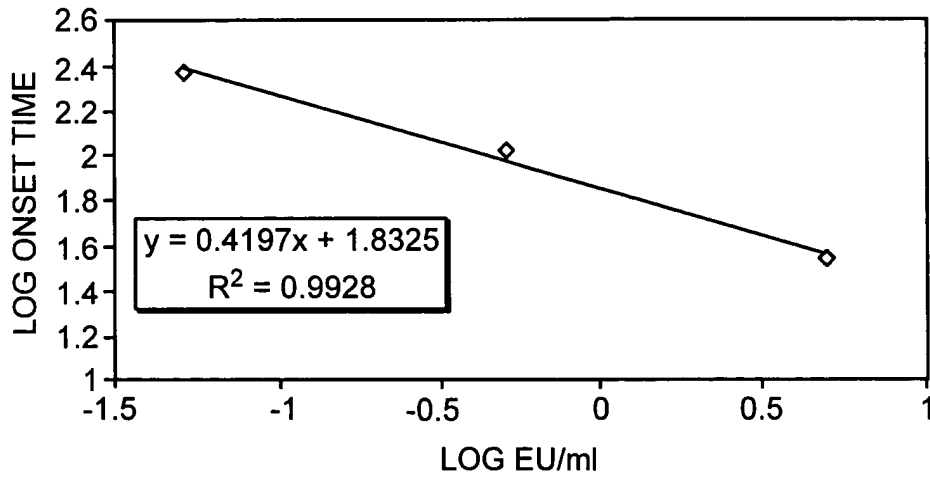

FIG. 12

16/20

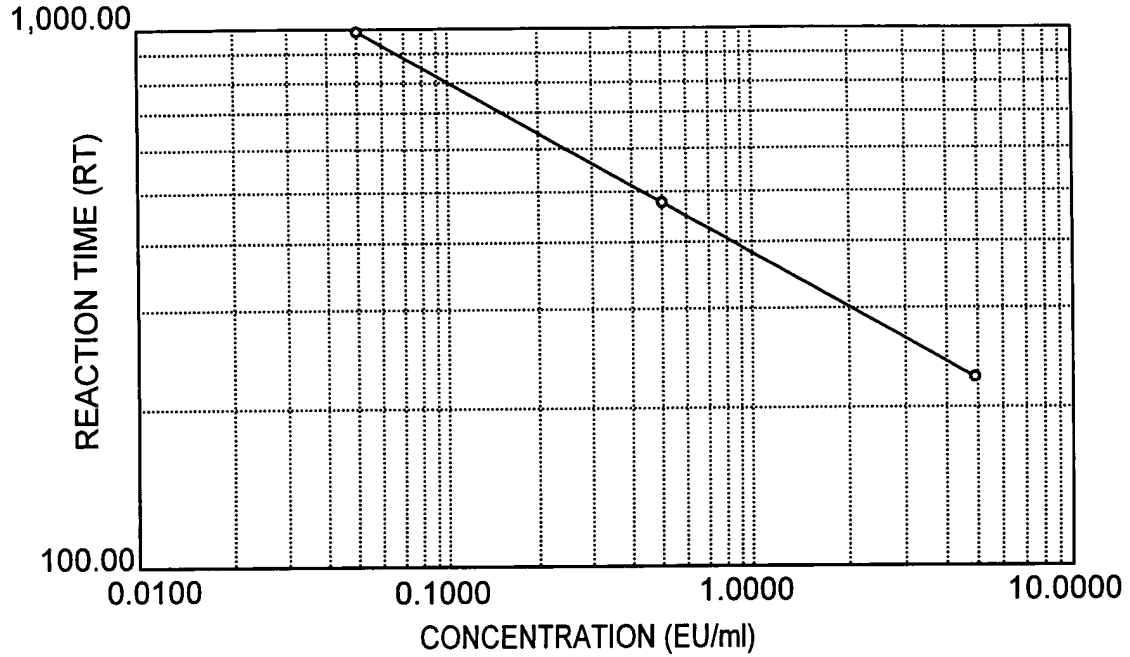

FIG. 13

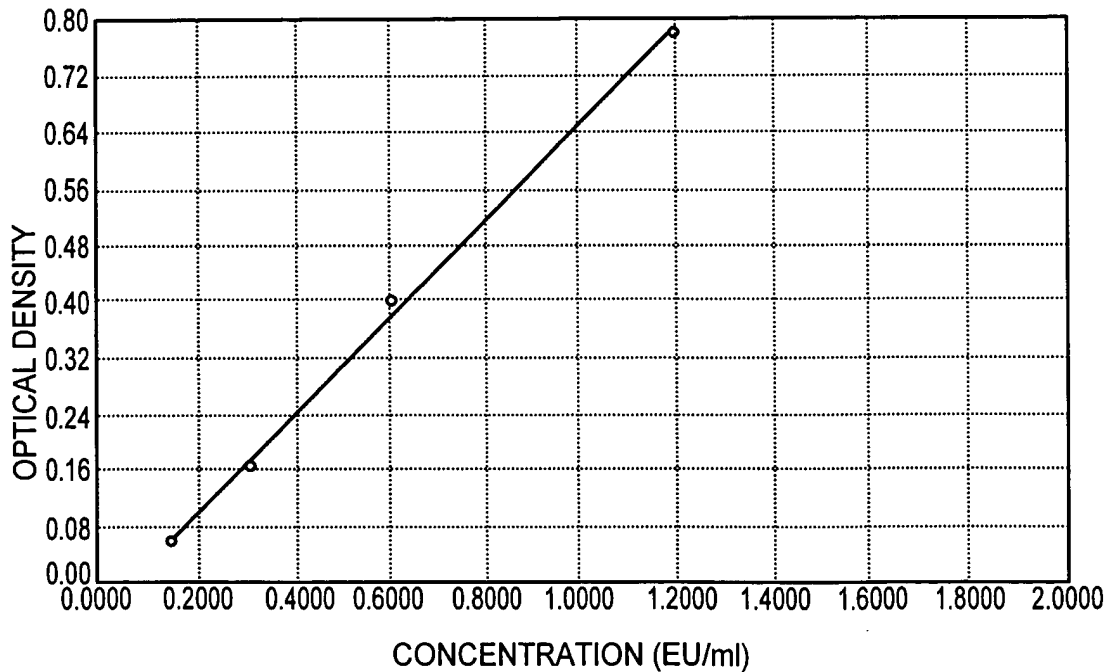

FIG. 14



17/20

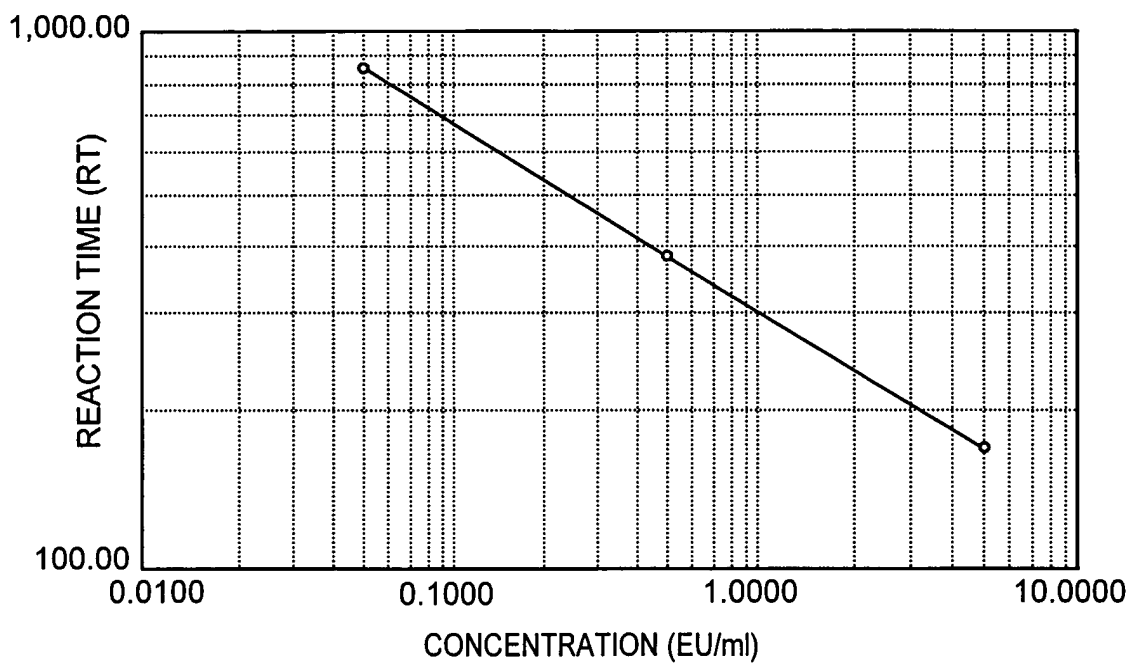

FIG. 15

18/20

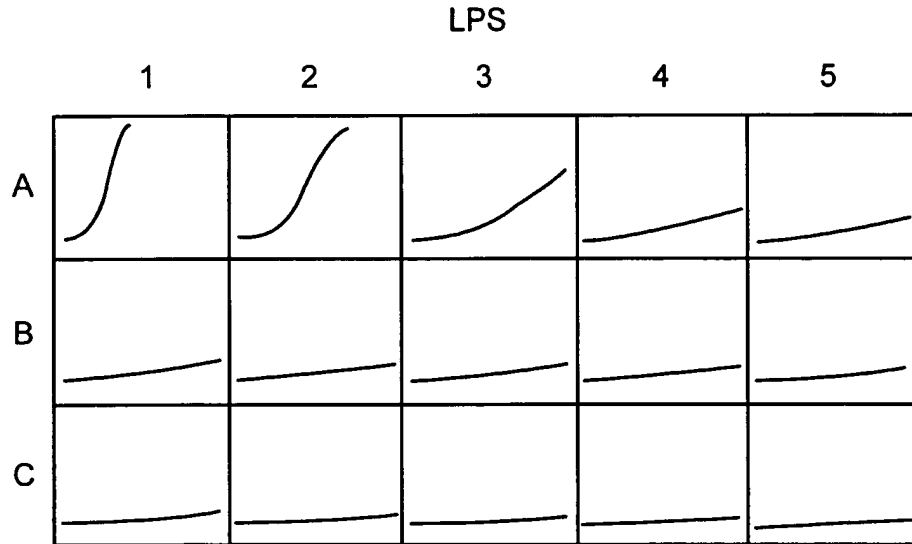

FIG. 16A

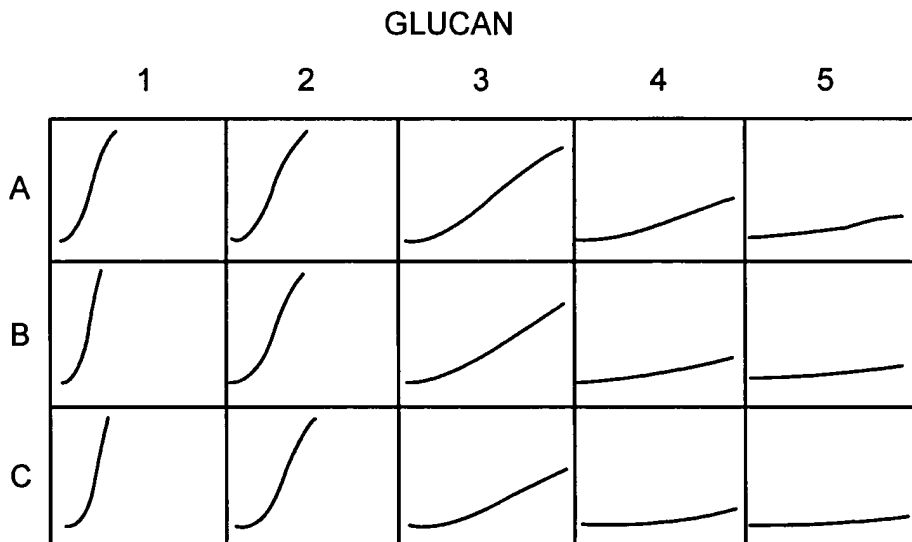

FIG. 16B

19/20

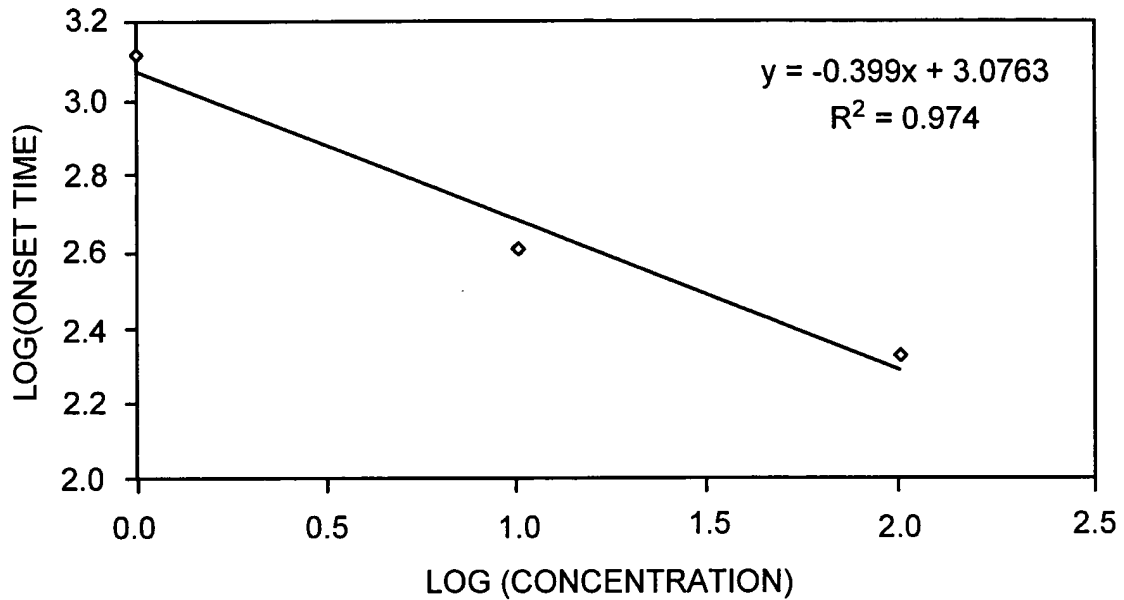

FIG. 17

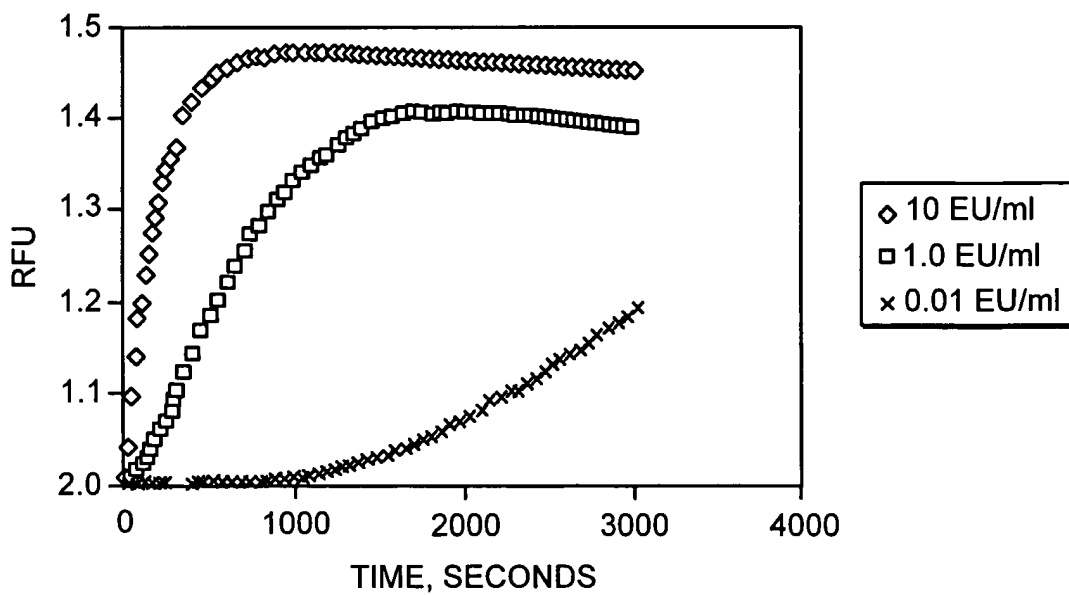
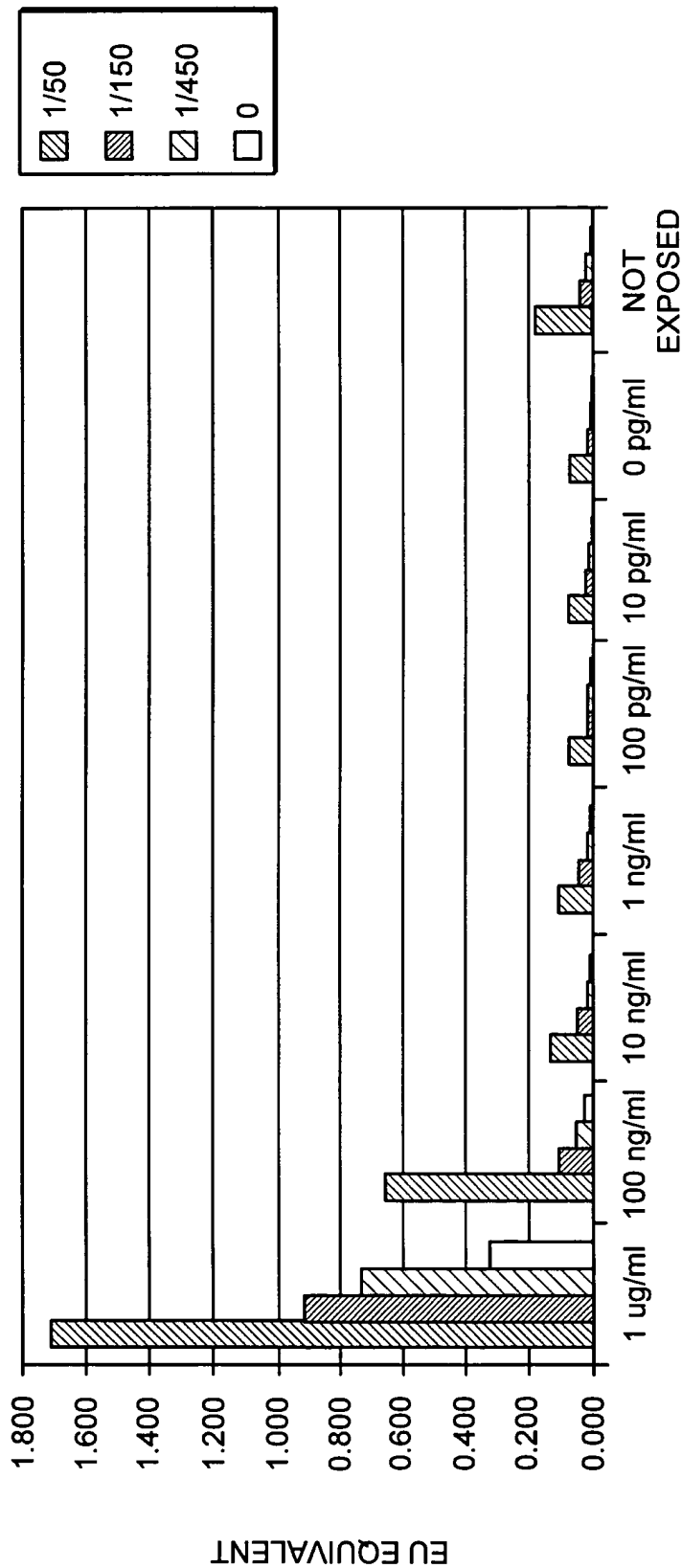

FIG. 18



LPS/FITC CONCENTRATION

FIG. 19